

# SBP2WEB24

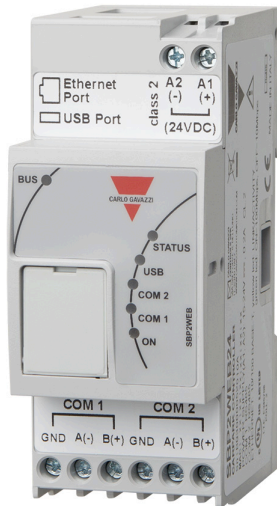

## Dupline® Carpark Controller



### Benefits

- Compact and flexible Carpark Controller
- Parking guidance, booking, carpark management and smart building controls in one system
- Energy savings through active occupancy management and lighting/ventilation control
- Can manage up to 7 Dupline® 3-wire networks, each with up to 90 carpark sensors
- Possibility to link up 10 controllers together with SBP2CPY24 carpark server
- Seamless integration with BMS through BACnet/IP
- Built-in webserver with user interface for carpark management software
- User-friendly PC-based configuration tool

### Description

The SBP2WEB24 Carpark Controller is part of the Dupline® Carpark system.

In addition to the Carpark sensors, indicators and display interfaces, it is also possible to connect other sensors and I/O-modules like PIR detectors, lux sensors, light switches, relay modules and DALI dimmers, thereby allowing energy saving functions for lighting and ventilation to be implemented in the same controller and network that manages the Carpark system.

The various I/O's and function parameters are available as BACnet/IP objects through the Ethernet port, thereby allowing seamless integration with any building management system. The SBP2WEB24 also features a Carpark management software implemented as webserver, with graphical user interface for monitoring and booking, alarm handling and statistics functions, all available through a standard browser.

### Applications

Parking Guidance Systems

### Main functions

- Management of Dupline® networks with sensors and displays and control functions for carpark guidance, as well as

functions for energy-saving lighting control and ventilation in the carpark.

### ▶ Main hardware characteristics

<b>Communication ports</b>	
RS485	1 port
Ethernet	1 port, for LAN connection
<b>Auxiliary bus</b>	
Right side	Compatible with Carpark SBP2MCG324



## Features

### Power Supply

Rated operational voltage	15- 24 VDC ( $\pm 20\%$ ), 0.2 A, CL.2
Rated impulse voltage	500 V (1.2/50 $\mu$ s) (IEC 60664-1, tab. F.1)
Rated operational power	5 W
Reverse-polarity protection	Yes
Connection	A1 (+) and A2 (-)
Power-OFF delay	1 s

### Input/output isolation

Type of input/output	DC Power supply	RS485 - COM 1	RS485 - COM 2	Ethernet	USB port "H" (host)	USB port "D" (service)	SH2UM-MF124
DC Power supply	-	2 kV	2kV	0.5 kV	0 kV	0 kV	0 kV
RS485 - COM 1	2 kV	-	0.5 kV		2 kV	2 kV	2 kV
RS485 - COM 2 (energy meter)	2 kV	0.5 kV	-	2 kV	2 kV	2 kV	2 kV
Ethernet (LAN/Internet)	0.5 kV	2 kV	2 kV	-	0.5 kV	0.5 kV	0.5 kV
USB port "H" (host)	0 kV	2 kV	2 kV	0.5 kV	-	0 kV	0 kV
USB port "D" (service)	0 kV	2 kV	2 kV	0.5 kV	0 kV	-	0 kV
SH2UM-MF124	0 kV	2 kV	2 kV	0.5 kV	0 kV	0 kV	-

- 0 kV: inputs/outputs are not insulated
- 0.5 kV rms: the insulation is functional type
- 2 kV rms: EN61010-1, IEC60664-1 - over-voltage category III, pollution degree 2, double insulation on systems with max. 300Vrms to ground

**LEDs indication**

<b>Green LED</b>	Power status	ON: power ON OFF: power OFF Flashing: 200ms ON 200ms OFF writing in progress on the $\mu$ SD memory, do not remove it.
<b>Yellow LED</b>	COM 1	OFF: no communications on RS485 A. Flashing: 200ms ON 600ms OFF, no answer from the slave. Flashing: 200ms ON 200ms OFF, communications OK.
	COM 2	OFF: no communications on RS485 B. Flashing: 200ms ON 600ms OFF, no answer from the slave. Flashing: 200ms ON 200ms OFF, communications OK.
	BUS	OFF: no communication is present on the HSbus. ON: communication error on HSbus. Flashing: communication OK on HSbus.
<b>Blue LED</b>	USB	ON: acknowledged device, no writing in progress, device can be removed. OFF: neither acknowledged device nor connected device. Flashing: acknowledged device and writing cycle in progress, device cannot be removed.
<b>Red LED</b>	Status	ON: NO configuration present. OFF: configuration present in the SBP2WEB24. Flashing: SBP2WEB24 is connected to the configuration tool.

**Environmental**

<b>Ambient temperature</b>	-25°... +50°C (-4°... +122°F) (R.H. < 90% non-condensing @ 40°C)	Operating
	-30° ... +70°C (-22° ... +158°F) (R.H. < 90% non-condensing @ 40°C)	Storage
<b>Dielectric strength</b>	4000 VAC rms	for 1 min.
<b>Noise rejection (CMRR)</b>	>65dB	45 to 65 Hz
<b>Overvoltage category</b>	III	IEC60664; EN60947-1. For inputs from string: equivalent to Cat. I, reinforced insulation.
<b>Standard compliance safety</b>	IEC60664, IEC61010-1, EN60664, EN61010-1	

**EMC**

Immunity According to EN61000-6-2	
Electrostatic discharges	IEC 61000-4-2
Radiated radiofrequency	EN61000-4-3
Burst immunity	EN61000-4-4
Surge	EN61000-4-5
Conducted radio frequency	EN 61000-4-6
Power frequency magnetic fields	EN 61000-4-8
Voltage dips, variations, interruptions	EN 61000-4-11
Emission According to EN61000-6-3	
Conducted and radiated emissions	CISPR 22 (EN55022), cl. B
Conducted emissions	CISPR 16-2-1 (EN55016-2-1)
Radiated emissions	CISPR 16-2-3 (EN55016-2-3)

**HS Bus specifications**

Bus type	RS485 high speed bus
Function	Connection to Carpark master generator (SBP2MCG324)
Number of slaves	Max 7
Connection	By local bus on the right side. <b>Note:</b> All the SBP2MCG324 modules have to be connected on the right side of the SBP2WEB24.

## Ports

### RS485

<b>Number of ports</b>	1
<b>Connections</b>	Multidrop, bidirectional (static and dynamic variables)
<b>Addresses</b>	247
<b>Protocol</b>	MODBUS
<b>Data (Bidirectional)</b>	All data
<b>Data format</b>	Selectable: 1 start bit, 7/8 data bit, no/odd/even/ parity, 1/2 stop bit
<b>Baud-rate</b>	Selectable: 9600, 19200, 38400, 115200, bits/s
<b>Driver input capability</b>	1/8 unit load. Up to 256 nodes on a network.
<b>Insulation</b>	See the table "Insulation between inputs and outputs"

### Ethernet

<b>Protocol</b>	HTTP
<b>IP configuration</b>	Static IP / Netmask / Default gateway
<b>DNS</b>	Primary and secondary DNS as a static or dynamic management (using DHCP server if configured)
<b>Connections</b>	RJ45 10/100 BaseTX, Max. distance: 100m
<b>Insulation</b>	See "Input/output insulation" table

# Mechanics

## Housing

<b>Dimensions (HxWxD)</b>	35 x 90 x 67 mm	
<b>Housing material</b>	Noryl, self-extinguishing V-0 (UL94)	
<b>Mounting</b>	DIN rail	
<b>Degree of protection</b>	Front	IP40
	Screw terminal	IP20
<b>Weight</b>	Approx. 150 g	Packing included

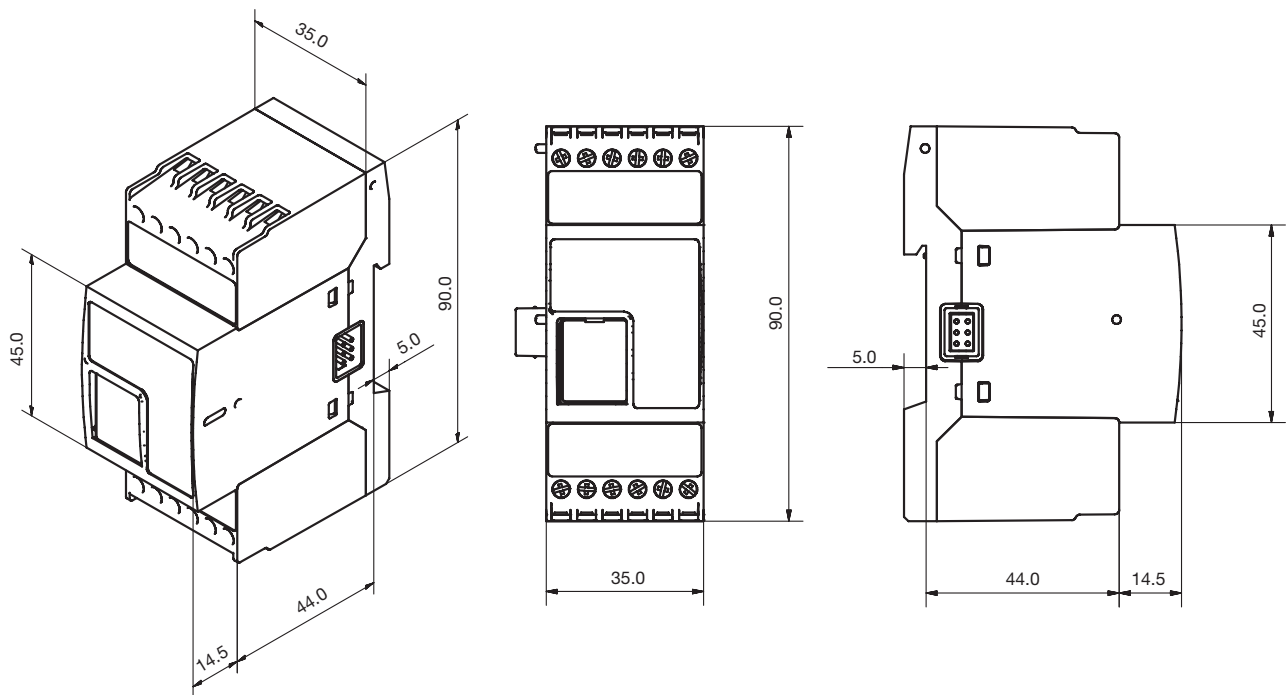

## Connection

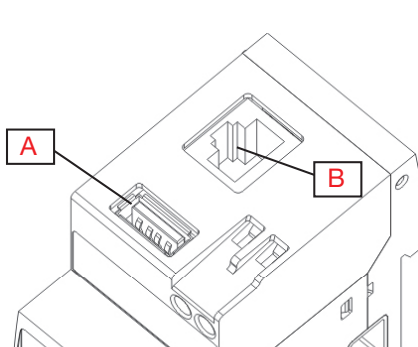

Fig. 1 USB host and LAN port

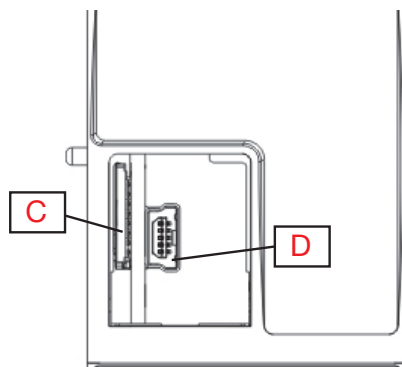

Fig. 2 Micro SD slot and mini USB

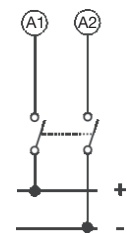

Fig. 3 Power supply

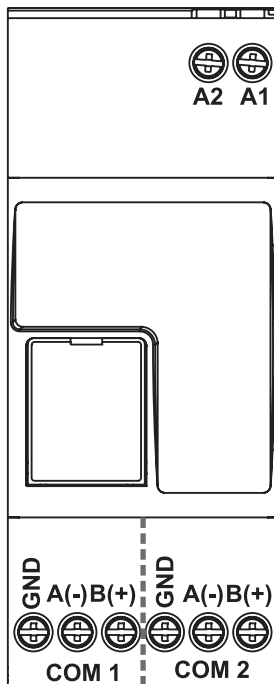

Fig. 4 Frontal connectors

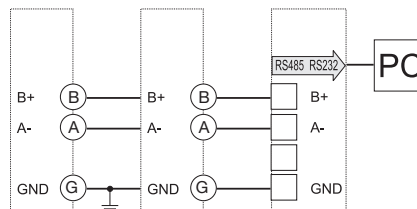

Fig. 5 RS485 port COM1

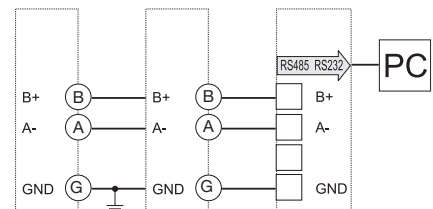

Fig. 6 RS485 port COM2

<b>A</b>	USB host	<b>C</b>	Micro SD slot
<b>B</b>	LAN port	<b>D</b>	Mini USB

**Connections**

<b>Ethernet</b>	RJ-45 connector	10/100Base-T
<b>RS485</b>	3 screw terminals per port	
	Cable cross-section area	1.5 mm <sup>2</sup> Max.
	Screws tightening torque	min. 0.4 Nm, Max. 0.8 Nm
<b>Power supply</b>	2 screw terminals	
	Cable cross-section area	1.5 mm <sup>2</sup> Max.
	Screws tightening torque	min. 0.4 Nm, Max. 0.8 Nm



## Mode of operation

The SBP2WEB24 Carpark controller needs to be configured to become operational.

When the SBP2WEB24 is connected to the TCP/IP network, the user can scan the system via the PC-based configuration tool to discover all Carpark sensors, LED indicators, displays etc. connected.

It is also possible to enter the modules manually in offline mode. Each Dupline® module has a so-called SIN address (printed on the packaging and on the module) which must be noted down in order to uniquely identify each module.

For the Carpark sensor, however, a faster method can be used. The SIN-addresses are simply read into the controller by bringing it into address read mode and then pressing the button in the bottom of each sensor one by one in a line.

Subsequently, the tool will automatically configure the connected Dupline® modules over the bus.

Once all modules with data points have been defined, it is possible to define the functions that use them.

Some of the functions are predefined with inputs, outputs and operational parameters, while others are standard types, such as logic, timers, real-time, sequence, data logging etc.

In order to ease testing and troubleshooting during commissioning, the configuration tool also provides the option to monitor live data from the SBP2WEB24.

All physical data points in the system and several function parameters are automatically made available as BACnet/IP objects, thereby providing an option for seamless integration with the building management system.

The SBP2WEB24 can also host the Carpark server software that controls the sensors, displays and indicators of the parking guidance system, manages alarms and bookings, and provides a graphical user interface via webserver.

Further information regarding programming can be found in the configuration manual.

This manual can be found on <http://productselection.net/searchproduct.php>

Further information regarding installation of CPIII can be found in the Installation manual.

This manual can be found on <http://productselection.net/searchproduct.php>

## Compatibility and conformity

### Approvals and markings

CE-marking	
Approvals	

#### UL notes

- This product is intended to be supplied by a Listed Information Technology Equipment AC Adaptor marked NEC Class 2 or LPS
- Max ambient temperature: 50°C (122°F)

## References

### Product selection key



SBP2WEB24

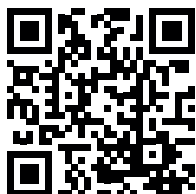

COPYRIGHT ©2016  
Content subject to change. Download the PDF: [www.productselection.net](http://www.productselection.net)